

THIS IS A C.A.D. GENERATED DRAWING  
DO NOT MAKE MANUAL REVISIONS TO MASTER.

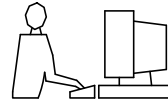

\* UNLESS OTHERWISE SPECIFIED TOLERANCES  
ON DECIMAL IS: ANGLE  $\pm 1^\circ$   
UNIT: MM .XX  $\pm 0.35$

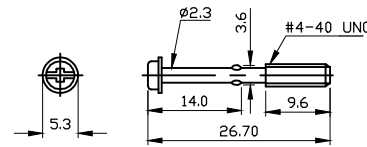
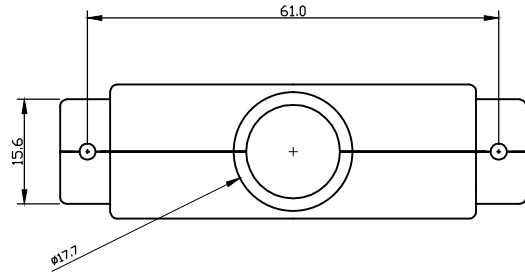

**MATERIAL:**  
INSULATOR : ABS UL94HB  
SCREW : STEEL  
FINISHED : CHROMATE PLATED  
R=ROHS  
SHORT SCREW  
INSULATOR COLOR  
C=METALIZED

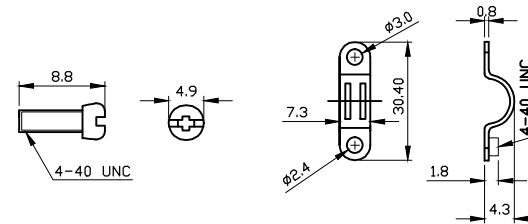
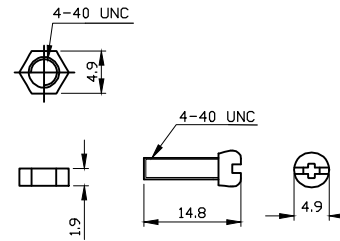
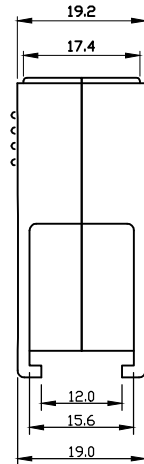
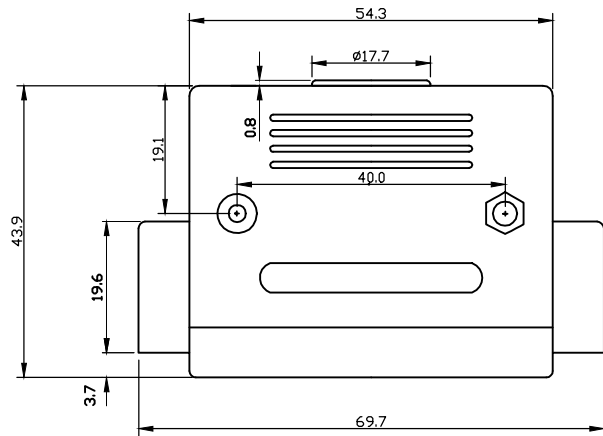

THESE DRAWINGS AND SPECIFICATIONS ARE THE PROPERTY OF MH CONNECTORS AND SHALL NOT BE REPRODUCED, COPIED OR USED AS THE BASIS FOR THE MANUFACTURE OR SALE OF APPARATUS WITHOUT WRITTEN PERMISSION.

DRAWN Johnny DATE 02-09-2023

APPROVED DATE

SCALE SHEET OF 1 OF 1 REV: 2.0

DRAWING No MHCCIV50-SC-MP



THIS SERIES FULLY CONFORMS TO THE EUROPEAN UNION DIRECTIVES 2015/863/EU AND 2011/65/EU FOR RoHS COMPLIANCY.



MH CONNECTORS ,  
DIVISION OF EDAC