

THIS IS A C.A.D. GENERATED DRAWING  
DO NOT MAKE MANUAL REVISIONS TO MASTER.



UNLESS OTHERWISE SPECIFIED TOLERANCES  
ON DECIMAL IS: ANGLE  
UNIT: MM X.  
X.X

1) Product main performance:

Operating Temperature: -55°C ~ 200°C  
Humidity(max): <=95% [at 60 deg C / 140 F]  
Shielding: 75dB(10MHz) 40dB(1GHz)  
Salt Spray Corrosion: 96hr  
P op (max): 60 bar (870 psi)

Mechanical data:  
Vibration: 15g[10Hz~2000Hz]  
Shock Resistance: 100g[6ms]  
Endurance (Shell): 5000+

Other Specification:  
Contact PIN: Gold plated Tin bronze  
Housing Material: Chrome plated brass  
Other metal spare parts: nickel plated brass  
Insulator material: PPS  
IP Rating: IP68  
\*ALL MATERIALS ARE RoHS COMPLIANT

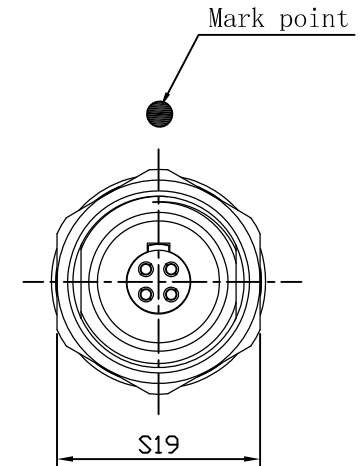
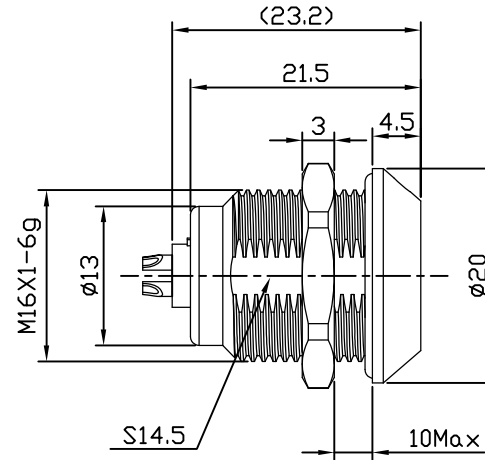

# MHCP1KxxSS

Pin Configuration

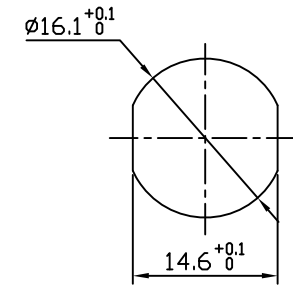

Panel cut-outs

Pin Configuration	02	03	04	05	06	07
Pin Number						
Pin Size (mm)	1.3	1.3	0.9	0.9	0.7	0.7
Withstand voltage (V) (AC)	1000	1000	875	875	875	875
Rated Current (A)	15.0	12.0	10.0	9.0	7.0	7.0
Insulation resistance (MΩ)	≥5000MΩ (500V(DC))					
R (max) (mΩ)	≤5	≤5	≤9	≤9	≤12.5	≤12.5
AWG (max) Stranded Wire	20	20	24	24	26	26

THESE DRAWINGS AND SPECIFICATIONS ARE THE PROPERTY OF MH CONNECTORS AND SHALL NOT BE REPRODUCED, COPIED OR USED AS THE BASIS FOR THE MANUFACTURE OR SALE OF APPARATUS WITHOUT WRITTEN PERMISSION.

DRAWN		DATE	
E.P.		23-10-23	
APPROVED		DATE	
S.R.		23-10-23	
SCALE	SHEET OF	REV:	
NA	1 OF 2	2	
DRAWING No			
MHCP1KxxSS			



THIS SERIES FULLY CONFORMS TO THE EUROPEAN UNION DIRECTIVES 2015/863/EU AND 2011/65/EU FOR RoHS COMPLIANCY.



MH CONNECTORS,  
DIVISION OF EDAC

THIS IS A C.A.D. GENERATED DRAWING  
DO NOT MAKE MANUAL REVISIONS TO MASTER.



UNLESS OTHERWISE SPECIFIED TOLERANCES  
ON DECIMAL IS: ANGLE  
UNIT: MM X.  
X.X

1) Product main performance:

Operating Temperature: -55°C~200°C  
Humidity(max): <=95% [at 60 deg C / 140 F]  
Shielding: 75dB(10MHz) 40dB(1GHz)  
Salt Spray Corrosion: 96hr  
P op (max): 60 bar (870 psi)

Mechanical data:  
Vibration: 15g[10Hz~2000Hz]  
Shock Resistance: 100g[6ms]  
Endurance (Shell): 5000+

Other Specification:  
Contact PIN: Gold plated Tin bronze  
Housing Material: Chrome plated brass  
Other metal spare parts: nickel plated brass  
Insulator material: PPS  
IP Rating: IP68  
\*ALL MATERIALS ARE RoHS COMPLIANT

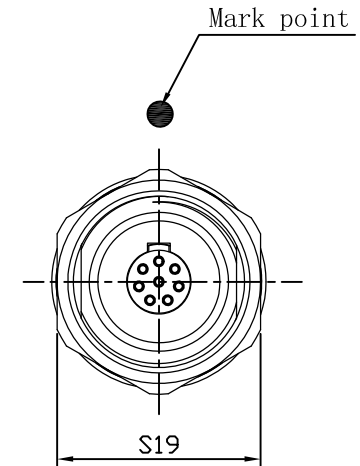
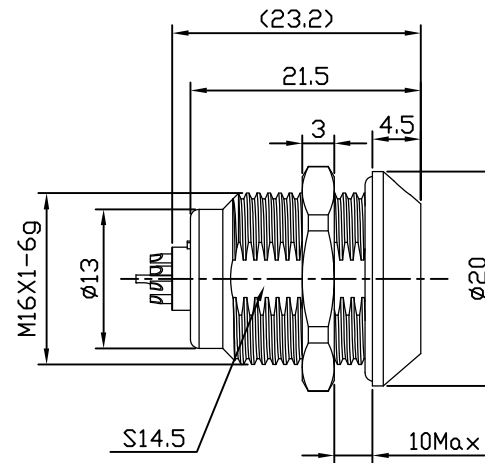

# MHCP1KxxSS

Pin Configuration

Pin Configuration	08	10	12	14	16
Pin Number					
Pin Size (mm)	0.7	0.5	0.5	0.5	0.5
Withstand voltage (V) (AC)	875	750	750	750	750
Rated Current (A)	5.0	2.5	2.0	2.0	1.5
Insulation resistance (MΩ)	≥5000MΩ (500V(DC))				
R (max) (mΩ)	≤12.5	≤15	≤15	≤15	≤15
AWG (max) Stranded Wire	26	28	28	28	28

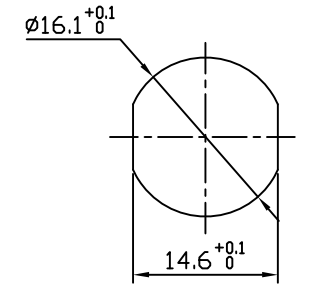

Panel cut-outs

THESE DRAWINGS AND SPECIFICATIONS ARE THE PROPERTY OF MH CONNECTORS AND SHALL NOT BE REPRODUCED, COPIED OR USED AS THE BASIS FOR THE MANUFACTURE OR SALE OF APPARATUS WITHOUT WRITTEN PERMISSION.

DRAWN		DATE	
E.P.		23-10-23	
APPROVED		DATE	
S.R.		23-10-23	
SCALE	SHEET OF	REV:	
NA	2 OF 2	2	
DRAWING No			
MHCP1KxxSS			



THIS SERIES FULLY CONFORMS TO THE EUROPEAN UNION DIRECTIVES 2015/863/EU AND 2011/65/EU FOR RoHS COMPLIANCY.



MH CONNECTORS,  
DIVISION OF EDAC