

THIS IS A C.A.D. GENERATED DRAWING
DO NOT MAKE MANUAL REVISIONS TO MASTER.

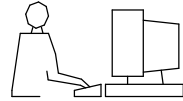

UNLESS OTHERWISE SPECIFIED TOLERANCES
ON DECIMAL IS: ANGLE
UNIT: MM X.
X.X

1) Product main performance:

Operating Temperature: -55°C~200°C
Humidity(max): <=95% [at 60 deg C / 140 F]
Shielding: 75dB(10MHz) 40dB(1GHz)
Salt Spray Corrosion: 96hr
P op (max): 60 bar (870 psi)

Mechanical data:

Vibration: 15g[10Hz~2000Hz]
Shock Resistance: 100g[6ms]
Endurance (Shell): 5000+

Other Specification:

Contact PIN: Gold plated Tin bronze
Housing Material: Chrome plated brass
Other metal spare parts: Nickel plated brass
Insulator material: PPS
IP Rating: IP68

*ALL MATERIALS ARE RoHS COMPLIANT

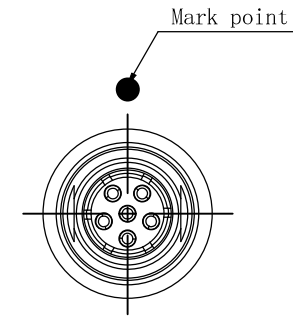
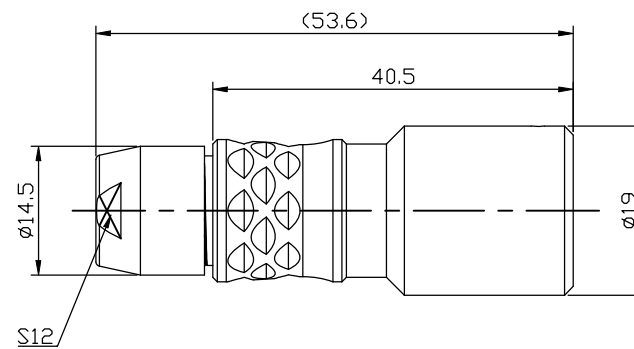

MHCP2KxxFSxx

Pin Configuration — Cable code

Pin Configuration	02	03	04	05	06	07	08	10
Pin Number								
Pin Size (mm)	2.0	1.6	1.3	1.3	1.3	1.3	0.9	0.9
Withstand voltage (V) (AC)	1000	1000	1000	1000	1000	1000	1000	1000
Rated Current (A)	30.0	17.0	15.0	14.0	12.0	11.0	10.0	8.0
Insulation resistance (MΩ)	≥5000MΩ (500V (DC))							
R (max) (mΩ)	≤3.5	≤4	≤5	≤5	≤5	≤5	≤9	≤9
AWG (max) Stranded Wire	16	16	20	20	20	20	24	24

Cable code	Cable diameter (mm)	
	Min	Maxi
50	4.1	5.0
60	5.1	6.0
70	6.1	7.0
80	7.1	8.0
90	8.1	9.0
100	9.1	10.0

THESE DRAWINGS AND SPECIFICATIONS ARE THE PROPERTY OF MH CONNECTORS AND SHALL NOT BE REPRODUCED, COPIED OR USED AS THE BASIS FOR THE MANUFACTURE OR SALE OF APPARATUS WITHOUT WRITTEN PERMISSION.

DRAWN E.P. DATE 23-10-23

APPROVED S.R. DATE 23-10-23

SCALE NA SHEET OF 1 OF 2 REV: 2

DRAWING No MHCP2KxxFSxx



THIS SERIES FULLY CONFORMS TO THE EUROPEAN UNION DIRECTIVES 2015/863/EU AND 2011/65/EU FOR RoHS COMPLIANCY.



MH CONNECTORS,
DIVISION OF EDAC

THIS IS A C.A.D. GENERATED DRAWING
DO NOT MAKE MANUAL REVISIONS TO MASTER.

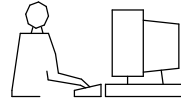

UNLESS OTHERWISE SPECIFIED TOLERANCES
ON DECIMAL IS: ANGLE
UNIT: MM X.
X.X

1) Product main performance:

Operating Temperature: -55°C~200°C
Humidity(max): <=95% [at 60 deg C / 140 F]
Shielding: 75dB(10MHz) 40dB(1GHz)
Salt Spray Corrosion: 96hr
P op (max): 60 bar (870 psi)

Mechanical data:

Vibration: 15g[10Hz~2000Hz]
Shock Resistance: 100g[6ms]
Endurance (Shell): 5000+

Other Specification:

Contact PIN: Gold plated Tin bronze
Housing Material: Chrome plated brass
Other metal spare parts: Nickel plated brass
Insulator material: PPS
IP Rating: IP68
*ALL MATERIALS ARE RoHS COMPLIANT

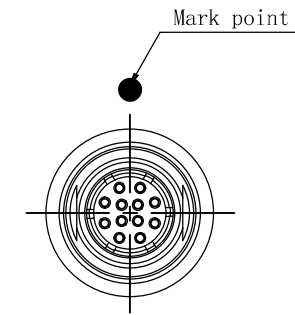
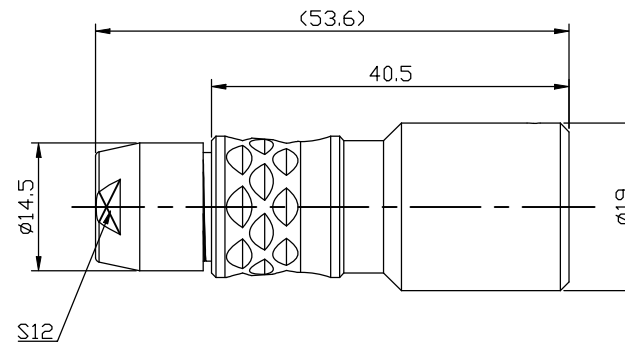

MHCP2KxxFSxx

Pin Configuration — Cable code

Pin Configuration	12	14	16	18	19	26	32
Pin Number							
Pin Size (mm)	0.7	0.7	0.7	0.7	0.7	0.5	0.5
Withstand voltage (V) (AC)	875	875	875	875	750	750	750
Rated Current (A)	7.0	6.5	6.0	5.5	5.0	2.0	1.5
Insulation resistance (MΩ)	≥5000MΩ (500V (DC))						
R (max) (mΩ)	≤12.5	≤12.5	≤12.5	≤12.5	≤12.5	≤15	≤15
AWG (max) Stranded Wire	26	26	26	26	26	30	30

Cable code	Cable diameter (mm)	
	Min	Maxi
50	4.1	5.0
60	5.1	6.0
70	6.1	7.0
80	7.1	8.0
90	8.1	9.0
100	9.1	10.0

THESE DRAWINGS AND SPECIFICATIONS ARE THE PROPERTY OF MH CONNECTORS AND SHALL NOT BE REPRODUCED, COPIED OR USED AS THE BASIS FOR THE MANUFACTURE OR SALE OF APPARATUS WITHOUT WRITTEN PERMISSION.

DRAWN E.P. DATE 23-10-23

APPROVED S.R. DATE 23-10-23

SCALE NA SHEET OF 2 OF 2 REV: 2

DRAWING No MHCP2KxxFSxx



THIS SERIES FULLY CONFORMS TO THE EUROPEAN UNION DIRECTIVES 2015/863/EU AND 2011/65/EU FOR RoHS COMPLIANCY.



MH CONNECTORS,
DIVISION OF EDAC